

Partition System T

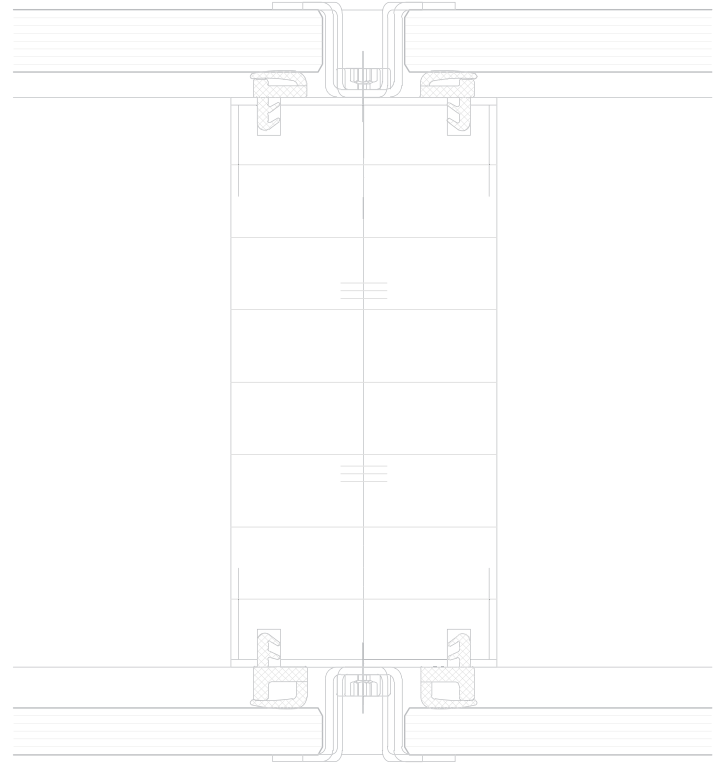

System T

Post-and-beam wall system
Wall thickness 100 mm

The partition wall System T with its wooden beam and post design creates a warm atmosphere within the room. The clean and minimalist design creates its visual effect from the relationship between wooden surfaces and flush glazing. The system offers a friendly and intelligent alternative to steel and aluminium structures.

System T is a relocatable partition wall system of beam and post design with a substructure of veneered plywood posts. The glass surfaces are fitted flush to the surface of the substructure using brushed stainless steel fixings. Timber as carbon-neutral material emphasises a sustainable architecture.



Double glazing

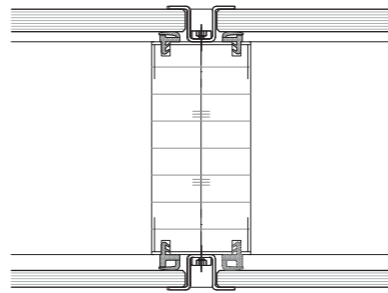

Design

Post-and-beam wall system, flush glazing system

Finish

Double glazing 6-8 mm toughened safety / laminated glass

Element types

Solid, balustrade, clerestory, fully-glazed

Surface

Posts veneered or coated

Wall thickness

100 mm

Section dimensions glass wall

35 mm

Sound insulation

up to Rwp 44 dB

Doors

Hinge door with timber or aluminium door frames
sliding doors (ceiling and bottom controlled)

Special elements

Acoustic absorption elements, blinds,
climate control elements

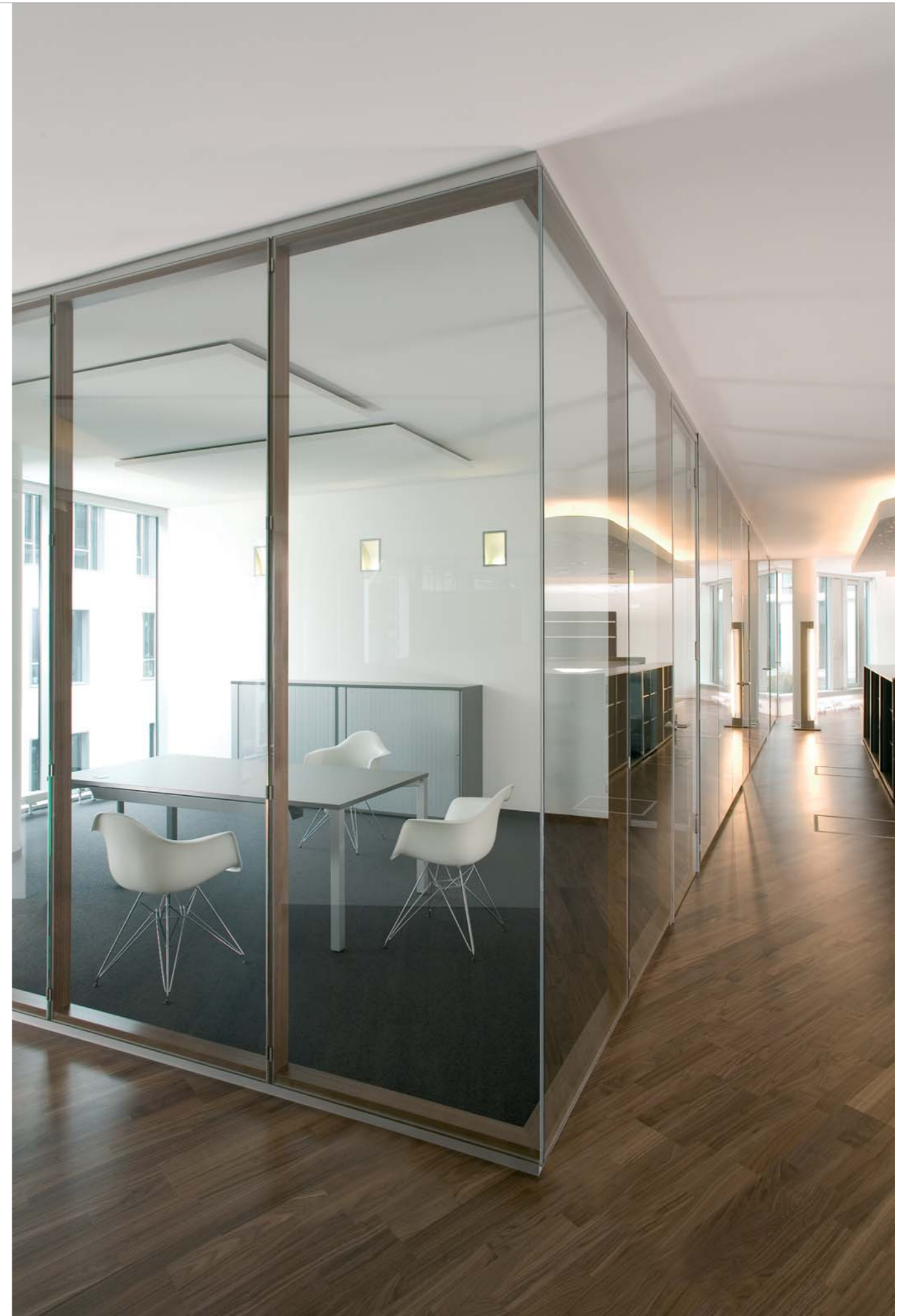

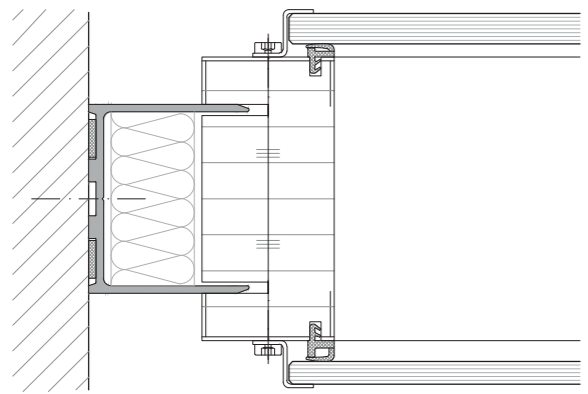

Glass element Wall connection

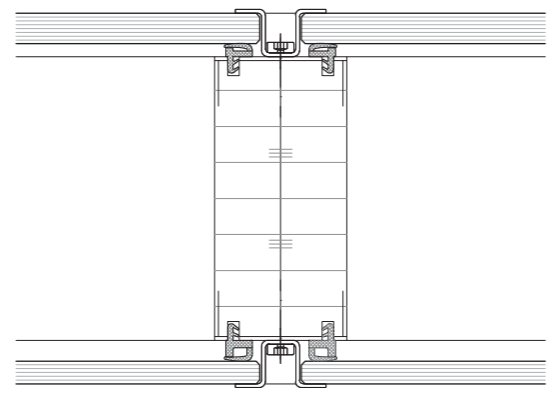

Glass element Modular grid joint

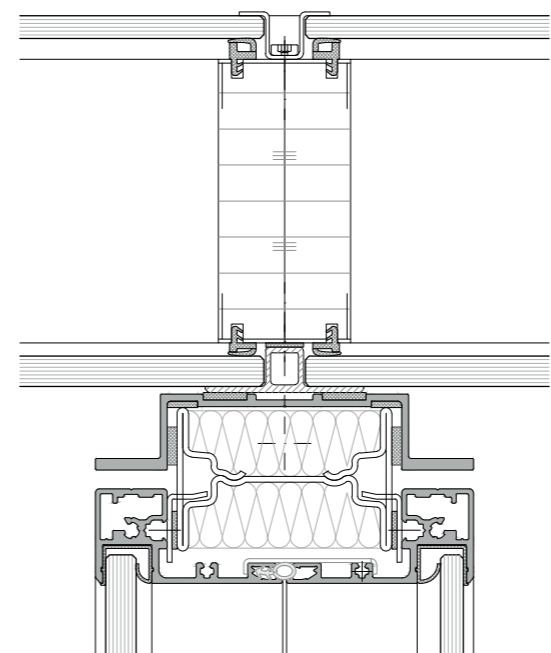

Glass element T-junction with System 2000

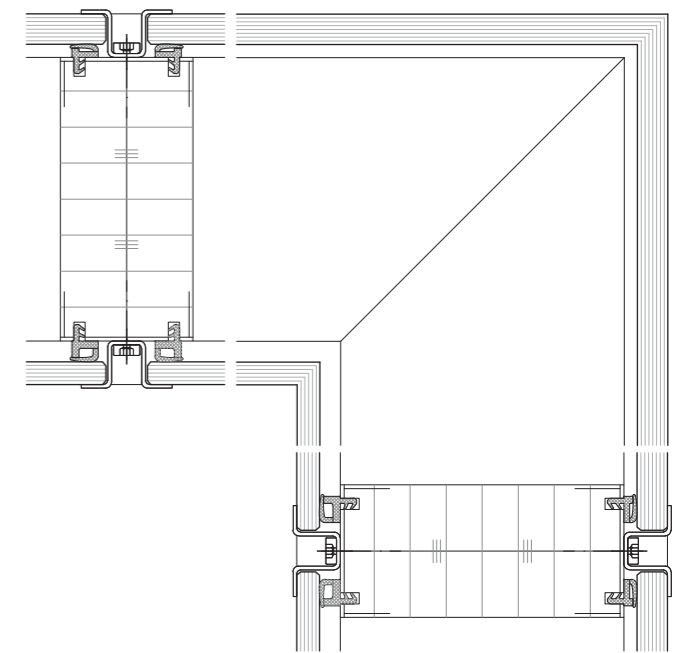

90 ° Corner element glazed (mitre)

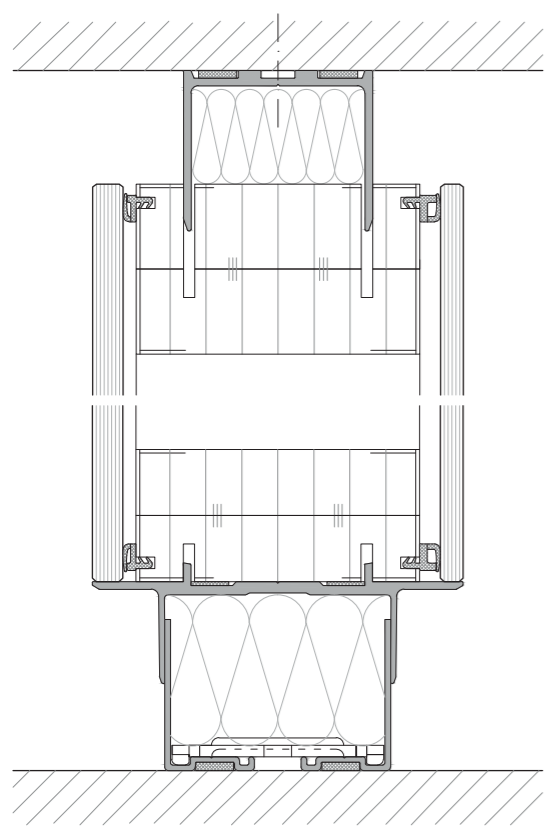

Glass element Floor- and ceiling connection

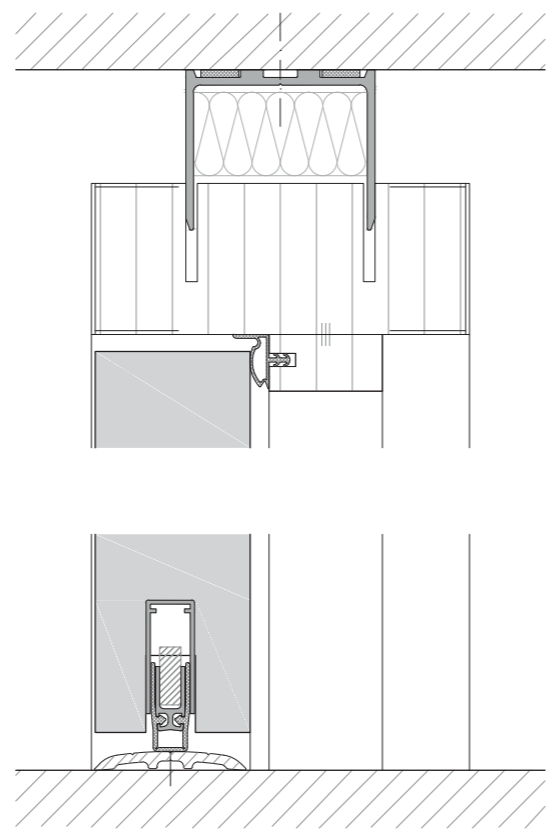

Door element Floor- and ceiling connection

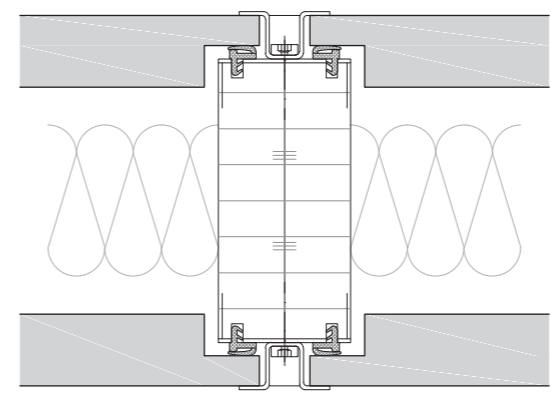

Solid wall Modular grid joint

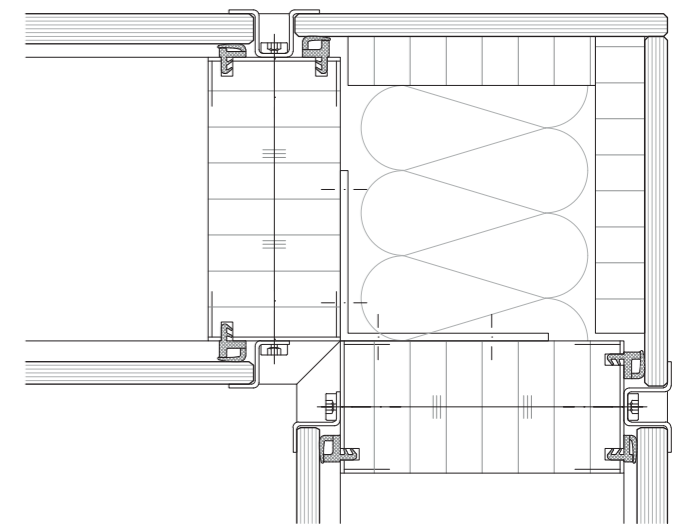

90 ° Corner element Timber with glass planked

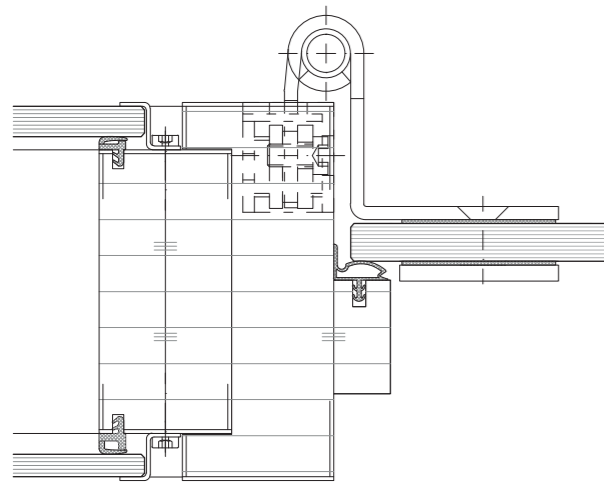

Fully-glazed door 10 mm

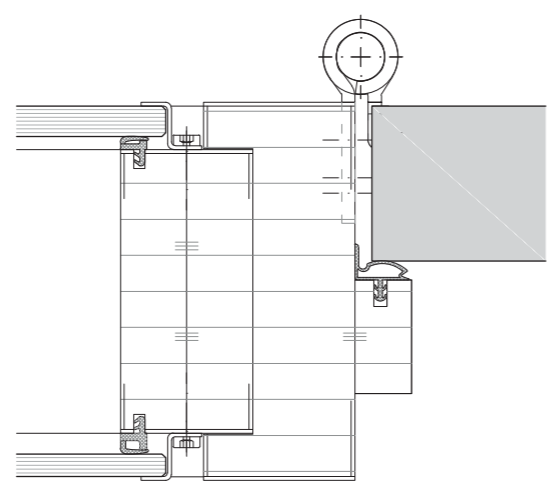

Solid door leaf 41 mm

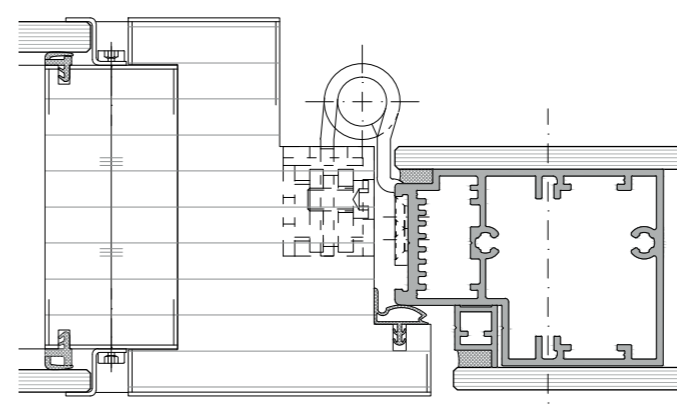

Structural glazing door 64 mm

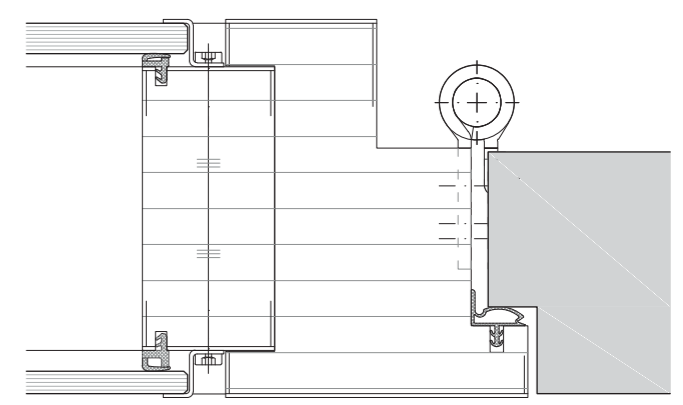

Solid door leaf 64 mm

Corridor wall with sliding door or hinged door

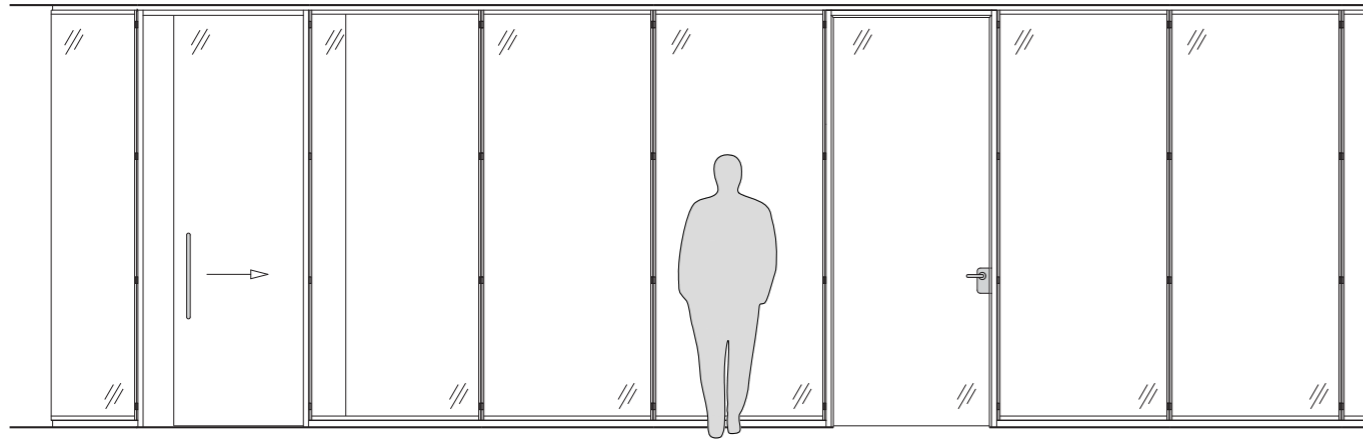

Partion wall	
Wall thickness	100 mm
Widths	Flexible grid with 3000 mm height and maximum grid width
Heights	Flexible grid, depending on installation grid, standard grid up to approx. 300 mm
Substructure	Posts of multiply wood material with only 35 mm visible width Cross-section vertical 35 x 75 mm / horizontal 40 x 75 mm
Substructure Connecting sections	Aluminium connecting sections anodized E6EV1 or powder coated to RAL colour
Deflection	+/- 8 mm in hight and width
Surfaces	Veneered or laquered finish to choice
Glazing	Double glazing with toughened or laminated safety glass
Door frames	- Wood surrounding frames with 35 mm or 65 mm visible section width - Aluminium frame as filigree frame with 35 mm visible section width
Fittings	3D adjustable stainless steel door hinges Door handle as per collection, stainless steel, office use
Door leaves Hinged doors	- VT 41 Solid timber door leaf 41 mm - VT 64 Solid timber door leaf 64 mm - GG 10 mm fully-glazed door - AR 40 aluminium framed door - AR 64 aluminium framed door - SG 64 structural glazing door
Sliding doors	- ST 10-B glass sliding door 10 mm toughened safety glass, floor-guided with stainless steel roller fitting - ST 10-D glass sliding door 10 mm toughened safety glass, suspended version with sliding door fitting attached to ceiling
Fire rating	Fire-rating not available

Element type	Construction / Description	Sound insulation in $R_{w,p}$ in dB
Glass elements double-glazed	6 mm toughened safety glass / 8 mm toughened safety glass	41 dB
	6 mm toughened safety glass / 8mm laminated safety glass SI (0,5)	44 dB
	Special elements with a higher insulation value on request	
Door elements	VT 41 solid door leaf 41 mm	37 dB
	VT 64 solid door leaf 64 mm	37 dB
	GG 10 fully-glazed door 10 mm toughened safety glass	32 dB
	AR 40 aluminium framed door 40 mm	32 dB (8 mm toughened safety glass) 37 dB (12 mm laminated safety glass)
	AR 64 aluminium framed door 64 mm with 38 mm insulating glazing	37 dB
	SG 64 structural glazing door 64 mm	37 dB



Strähle Raum-Systeme GmbH
www.straehle.de
info@straehle.de

Gewerbestraße 6
71332 Waiblingen
T +49 7151 1714-0
F +49 7151 1714-320

Wurzelweg 5
14822 Borkheide
T +49 33845 66-0
F +49 33845 66-199

Austria
Industriestraße 9
2353 Guntramsdorf
T +43 2236 23232-0
F +43 2236 23232-13

Switzerland
Dellenbodenweg 1
4452 Itingen
T +41 61 463 1332
F +41 61 463 1333